

SUBMITTAL DATA SHEET

NL Meter Setter – 710-303NNHS X72

Male Meter x Male Meter

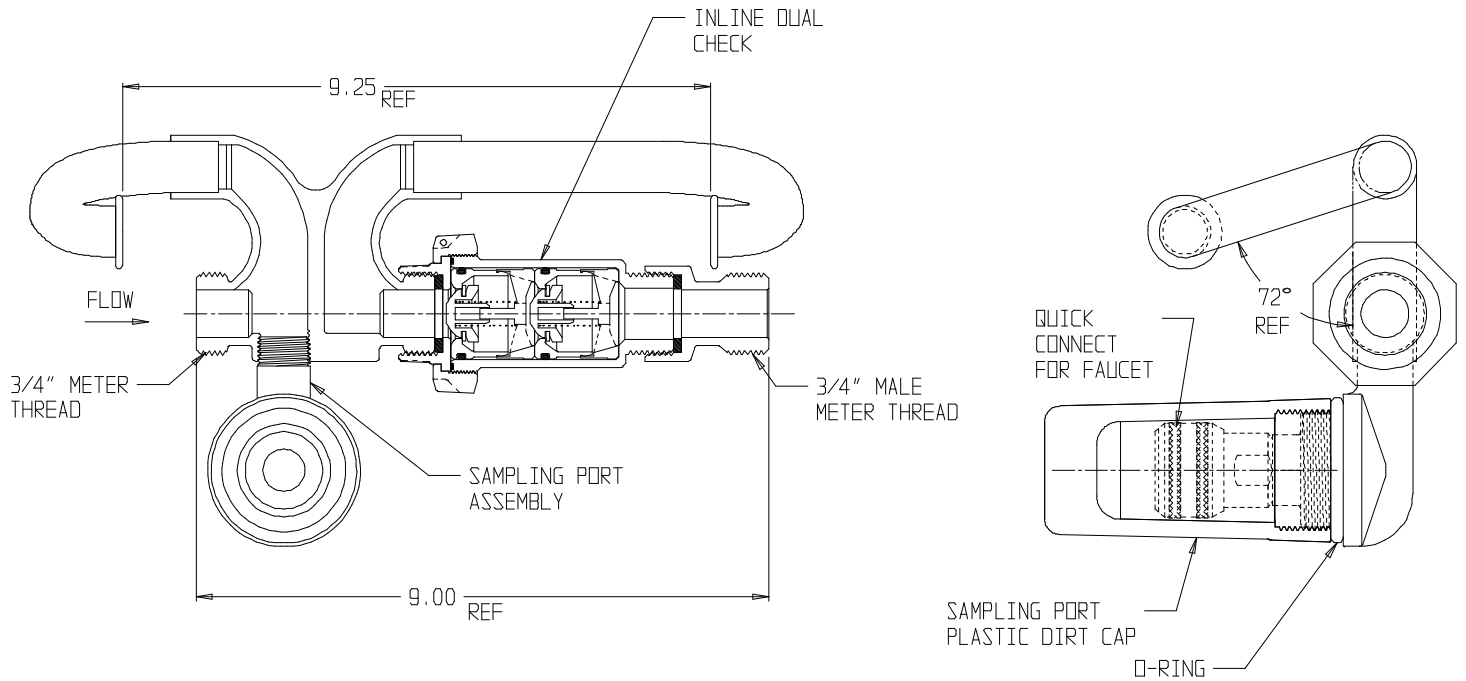

SUBMITTAL INFORMATION

- Brass components in contact with potable water complies with USA public law 111-380 and identified with "NL"
- Copper tubing made in compliance with ASTM B75 or B88, UNS C12200 (latest revision)
- Lead free solder joints
- Designed to provide proper meter spacing for ease of installation
- Padlock wings standard on all valves
- Dual check manufactured in compliance with ANSI/ASSE 1024 (latest revision) and rated for 175 PSIG water pressure



A.Y. McDonald Mfg. Co.
4800 Chavenelle Rd
Dubuque, IA 52002

Toll Free: 1-800-292-2737
sales@aymcdonald.com
aymcdonald.com

A.Y. McDonald considers the information on this assembly drawing correct when published. Item and option availability, including specifications, are subject to change without notice.

Submitted by:

08-14