

SUBMITTAL DATA SHEET

Ductile Iron Saddle with Stainless Steel Strap – 4835A

C900 PVC x AWWA/CC



MODEL	SIZE	A	B
4835A	4 X 3/4	3/4	4.50 - 4.80
4835A	4 X 1	1	4.50 - 4.80
4835A	4 X 1 1/4	1 1/4	4.50 - 4.80
4835A	4 X 1 1/2	1 1/2	4.50 - 4.80
4835A	4 X 2	2	4.50 - 4.80
4835A	6 X 3/4	3/4	6.63 - 6.90
4835A	6 X 1	1	6.63 - 6.90
4835A	6 X 1 1/4	1 1/4	6.63 - 6.90
4835A	6 X 1 1/2	1 1/2	6.63 - 6.90
4835A	6 X 2	2	6.63 - 6.90
4835A	8 X 3/4	3/4	8.63 - 9.05
4835A	8 X 1	1	8.63 - 9.05
4835A	8 X 1 1/4	1 1/4	8.63 - 9.05
4835A	8 X 1 1/2	1 1/2	8.63 - 9.05
4835A	8 X 2	2	8.63 - 9.05
4835A	10 X 3/4	3/4	10.75 - 11.10
4835A	10 X 1	1	10.75 - 11.10
4835A	10 X 1 1/4	1 1/4	10.75 - 11.10
4835A	10 X 1 1/2	1 1/2	10.75 - 11.10
4835A	10 X 2	2	10.75 - 11.10
4835A	12 X 3/4	3/4	12.75 - 13.20
4835A	12 X 1	1	12.75 - 13.20
4835A	12 X 1 1/4	1 1/4	12.75 - 13.20
4835A	12 X 1 1/2	1 1/2	12.75 - 13.20
4835A	12 X 2	2	12.75 - 13.20

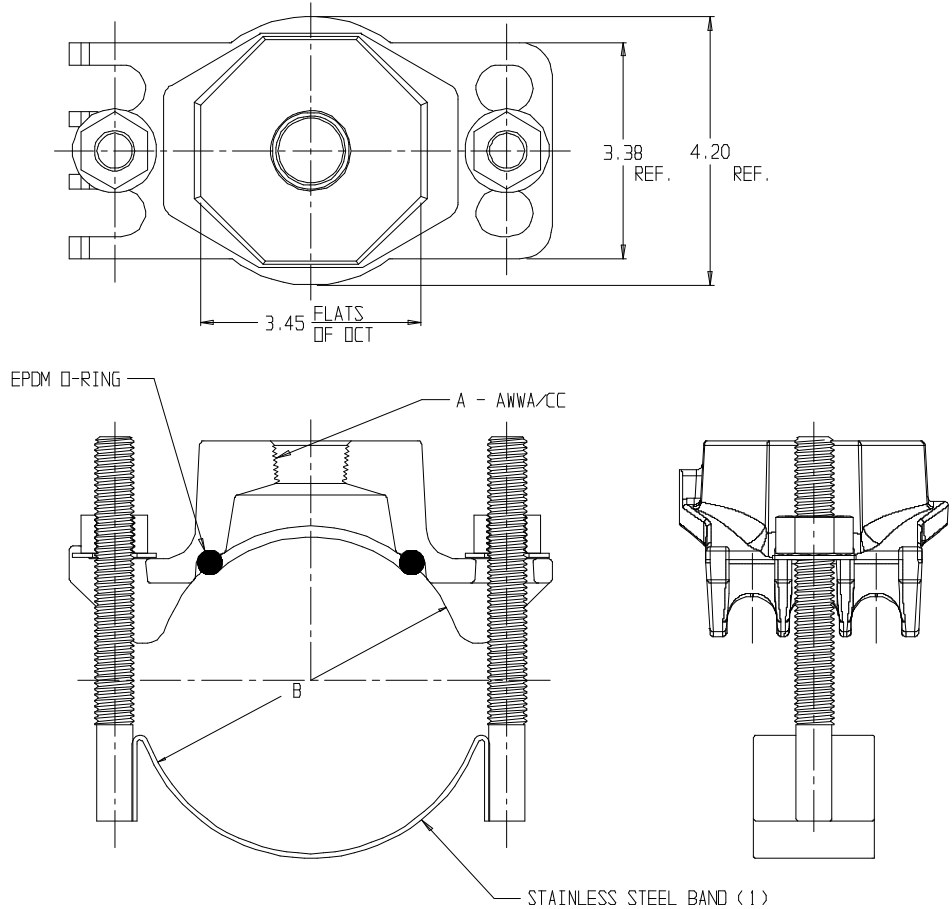

SUBMITTAL INFORMATION

- Manufactured in compliance with ANSI/AWWA C800 (latest revision)
- Ductile iron conforms to ASTM A536 class 65-45-12 (latest revision)
- Certified to NSF/ANSI 61
- 304L Stainless Steel strap(s) and studs. Stainless steel nuts (PTFE coated) and washers
- EPDM o-ring
- Pipe and tap size, and thread type identified on saddle
- Outlet boss with large wrench flats
- Powder coated with blue epoxy



A.Y. McDonald Mfg. CO.
4800 Chavenelle Rd
Dubuque, IA 52002

Toll Free: 1-800-292-2737
sales@aymcdonald.com
aymcdonald.com

A.Y. McDonald considers the information on this assembly drawing correct when published. Item and option availability, including specifications, are subject to change without notice.

Submitted by: