

SUBMITTAL DATA SHEET

Yoke & Long Box Iron Component – 76-US12

Upper Section Only

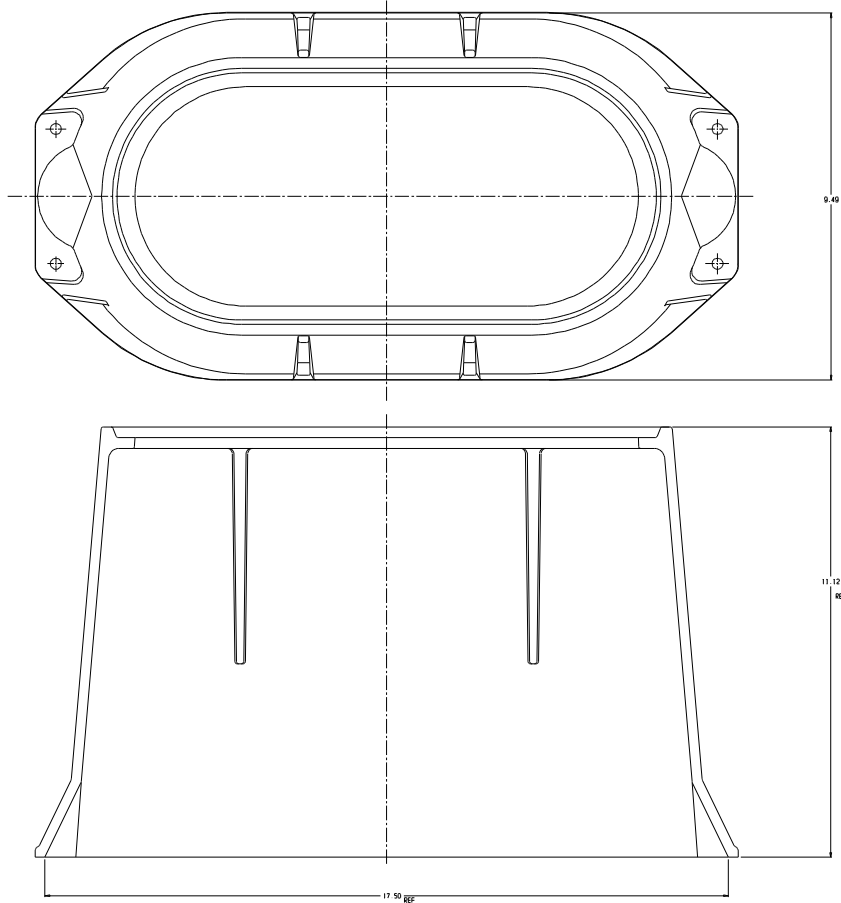

SUBMITTAL INFORMATION

- Cast iron components conforms to ASTM A126 Class B or ASTM A159 Grade 2500 (latest revision) and coated with black dip



A.Y. McDonald Mfg. Co.
4800 Chavenelle Rd
Dubuque, IA 52002

Toll Free: 1-800-292-2737
sales@aymcdonald.com
aymcdonald.com

A.Y. McDonald considers the information on this assembly drawing correct when published. Item and option availability, including specifications, are subject to change without notice.

Submitted by:

09-18