

SUBMITTAL DATA SHEET

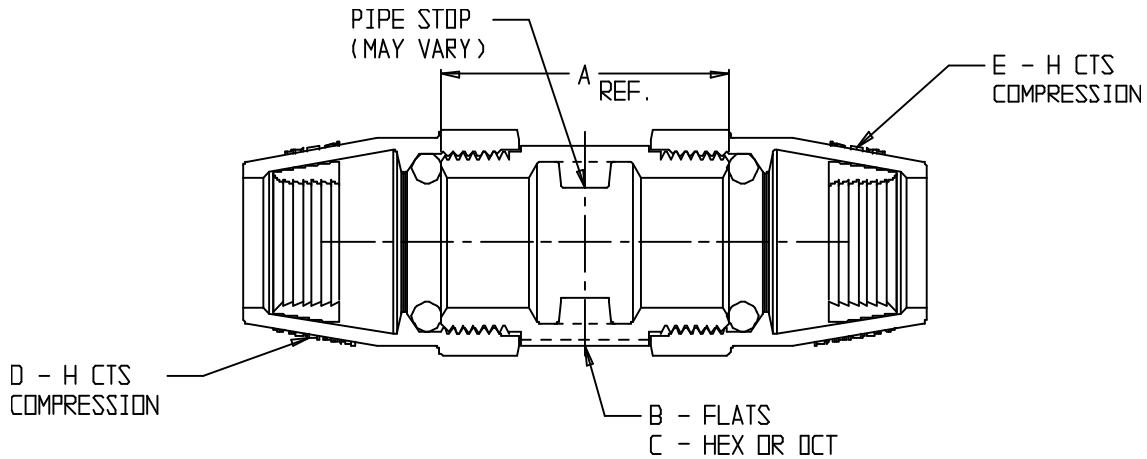

NL Service Fitting – 74759H

H CTS Compression x H CTS Compression



MODEL	SIZE	A	B	C	D	E
74759H	3/4	2.00	1.34	OCT	3/4	3/4
74759H	3/4 X 1	2.11	1.38	OCT	3/4	1
74759H	1	2.40	1.38	OCT	1	1

SUBMITTAL INFORMATION

- Manufactured in compliance with ANSI/AWWA C800 (latest revision)
- Brass components in contact with potable water conform to ASTM B584, UNS C89833 (latest revision) and identified with “NL”
- Certified to NSF/ANSI 61 and NSF/ANSI 372
- Brass components not in contact with potable water conform to ASTM B62 and ASTM B584, UNS C83600 -85-5-5-5 (latest revision)
- Large wrench flats provided for proper installation



A.Y. McDonald Mfg. Co.
4800 Chavenelle Rd
Dubuque, IA 52002

Toll Free: 1-800-292-2737
sales@aymcdonald.com
aymcdonald.com

A.Y. McDonald considers the information on this assembly drawing correct when published. Item and option availability, including specifications, are subject to change without notice.

Submitted by: