

SUBMITTAL DATA SHEET

Frame & Cover – 74M3ATC

11 ½" A Cover x 20" Frame

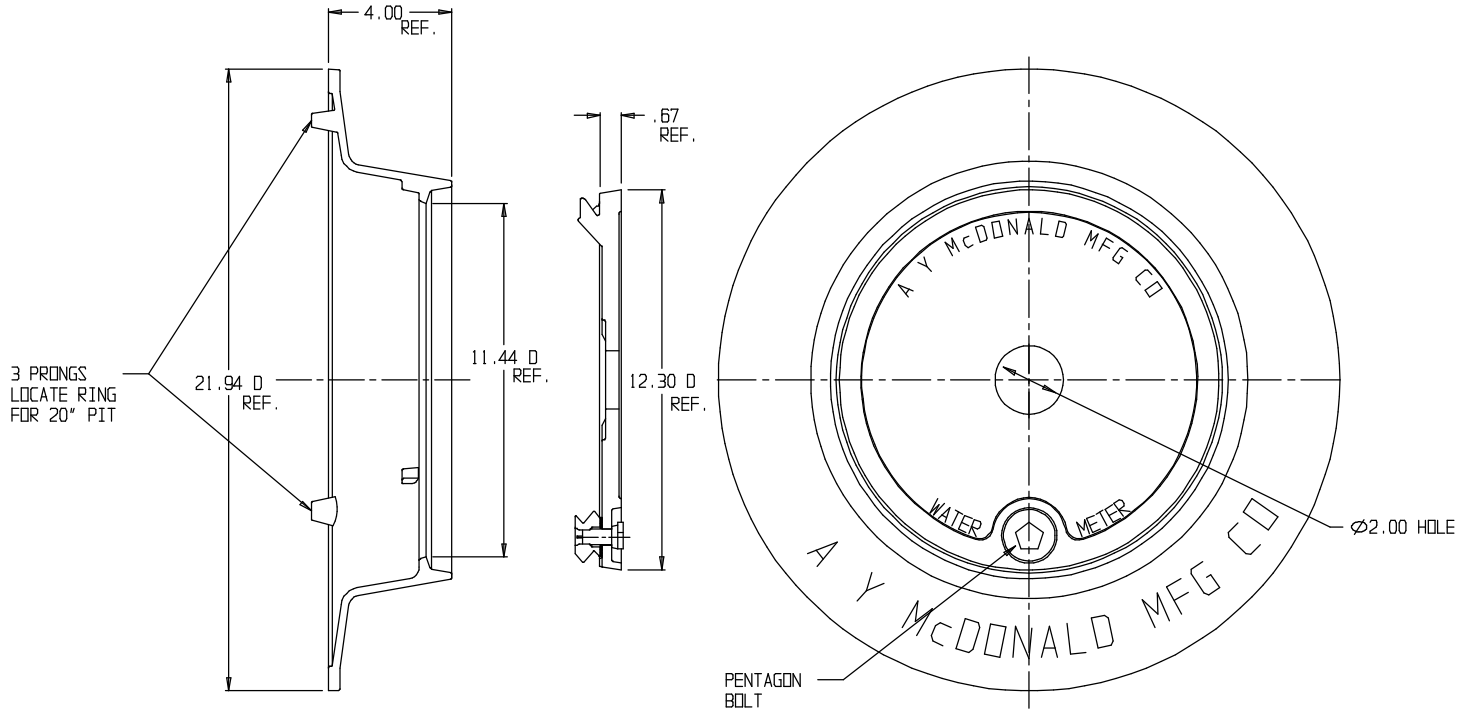

SUBMITTAL INFORMATION

- Cast Iron per ASTM A48, Class 25
- Coated with black dip
- Locking lid utilize Silicon Bronze pentagon bolt with copper and HDPE washers



A.Y. McDonald Mfg. Co.
4800 Chavenelle Rd
Dubuque, IA 52002

Toll Free: 1-800-292-2737
sales@aymcdonald.com
aymcdonald.com

A.Y. McDonald considers the information on this assembly drawing correct when published. Item and option availability, including specifications, are subject to change without notice.

Submitted by:

09-14