

# SUBMITTAL DATA SHEET

Yoke & Long Box Iron Component – 75L7

Cast Iron Lid Only

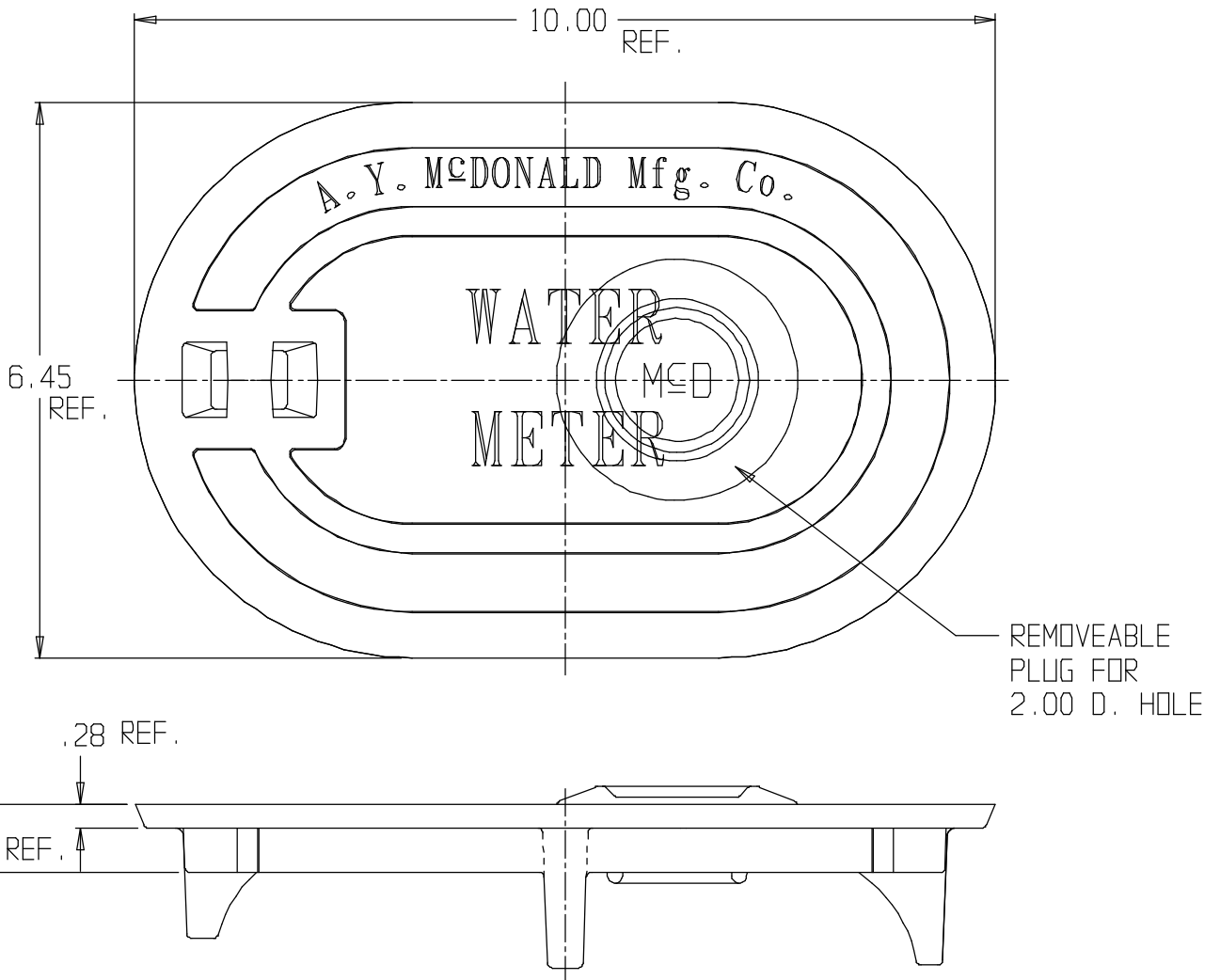

## SUBMITTAL INFORMATION

- Cast iron components conforms to ASTM A126 Class B or ASTM A159 Grade 2500 (latest revision) and coated with black dip



**A.Y. McDonald Mfg. Co.**  
4800 Chavenelle Rd  
Dubuque, IA 52002

**Toll Free: 1-800-292-2737**  
[sales@aymcdonald.com](mailto:sales@aymcdonald.com)  
[aymcdonald.com](http://aymcdonald.com)

A.Y. McDonald considers the information on this assembly drawing correct when published. Item and option availability, including specifications, are subject to change without notice.

**Submitted by:**