

# SUBMITTAL DATA SHEET

NL Coil Pit Setter – 790-248QFPP 330X15X992

MNPT x MNPT

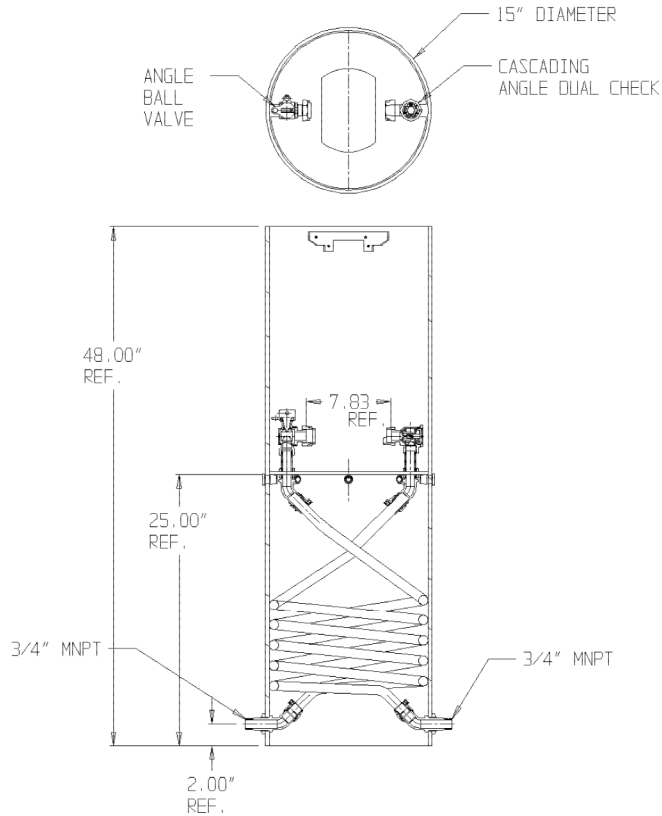

## SUBMITTAL INFORMATION

- Manufactured in compliance with ANSI/AWWA C800 (latest revision)
- Brass components in contact with potable water conform to ASTM B584, UNS C89833 (latest revision) and identified with “NL”
- Certified to NSF/ANSI 61 and NSF/ANSI 372
- Brass components not in contact with potable water conform to ASTM B62 and ASTM B584, UNS C83600 -85-5-5-5 (latest revision)
- Coiled CTS tubing made from Polyethylene or Engineered Polymer Materials
- Stainless steel insert stiffeners designed to optimize flow
- Heavy wall PVC shell and impact resistant rigid meter platform
- Large wrench flats provided for proper installation



**A.Y. McDonald Mfg. Co.**  
4800 Chavenelle Rd  
Dubuque, IA 52002

**Toll Free: 1-800-292-2737**  
sales@aymcdonald.com  
[aymcdonald.com](http://aymcdonald.com)

A.Y. McDonald considers the information on this assembly drawing correct when published. Item and option availability, including specifications, are subject to change without notice.

**Submitted by:**

04-20